



## Dielectric Microwave Components - Filter / Resonator / Antenna

● Dielectric Filters DF Band Pass Series / 介质滤波器 .....	1
● Dielectric Resonators TE <sub>01δ</sub> Mode / 介质谐振器 .....	13
● Coaxial Resonators TEM Mode Dielectric DR Series / 同轴谐振器 .....	15
● Dielectric Antenna / 介质天线 .....	18

Notice: Specification Changed or Version Updated will be posted at irregular intervals.  
All Updated and Final Specifications, Please Confirm with TOKEN ELECTRONICS REPRESENTIVES.



<http://www.token.com.tw>



[rfq@tokenonline.net](mailto:rfq@tokenonline.net)

**Taiwan:** No. 137, Sec. 1, Chung Shin Rd., Wu Ku Hsiang, Taipei Hsien, Taiwan, R.O.C  
TEL: 886-2-2981 0109; FAX: 886-2-2988 7487

**China:** 12F, Zhongxing Industry Bld., Chuangye Rd., Nanshan District, Shenzhen, Guangdong  
TEL: 86-755-2605 5363, 2605 5364; FAX: 86-755-2605 5365



# Dielectric

## DF Band Pass Series Dielectric Filters / 介质滤波器

DF Series (SMD type) Filter with high permittivity, high dielectric constants, extremely temperature stability and high Q that enables the design of stable microwave oscillators and filters. High dielectric materials and associated products are also available for custom application requirements. Applications for CT1, CT2, 900MHz, 1.8GHz, 2.4GHz, 5.8GHz Cordless Phone, wireless earphone, wireless microphone.

### ► DF - A Type Filters Configuration



### DF - A Type Dimensions (Unit: mm)

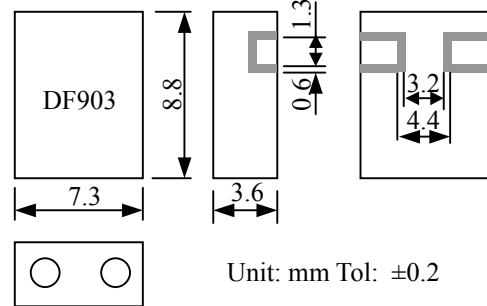

### ► Band Pass DF Filter Typical Specifications

Part No.	Center Frequency (MHz)	Band Width (MHz)	Insertion Loss (dB)max.	Ripple in Band Width (dB)max.	V.S.W.R max.	Attenuation (dB)min.(MHz)
DF457S30A	457	$f_0 \pm 15$	3.0	1.0	2.0	17 at $f_0 + 50$ ; 30 at $f_0 - 50$
DF522S10A	522	$f_0 \pm 5$	3.0	0.5	1.6	23 at $f_0 + 40$ ; 40 at $f_0 - 40$
DF683S30A	683	$f_0 \pm 15$	2.5	1.0	2.0	20 at $f_0 + 64$ ; 30 at $f_0 - 64$
DF740S30A	740	$f_0 \pm 15$	2.0	0.5	1.8	14 at $f_0 + 64$ ; 20 at $f_0 - 64$
DF864S10A	864	$f_0 \pm 5$	2.5	0.5	1.5	15 at $f_0 + 24$ ; 17 at $f_0 - 24$
DF915S25A	915	$f_0 \pm 12.5$	2.0	1.0	2.0	20 at $f_0 + 100$ ; 35 at $f_0 - 100$
DF903S6A	903	$f_0 \pm 3$	3.5	0.5	1.5	32 at $f_0 + 24$
DF927S6A	927	$f_0 \pm 3$	3.5	0.5	1.5	32 at $f_0 - 24$
DF1890S80A	1890	$f_0 \pm 40$	1.5	1.0	2.0	15 at $f_0 + 200$ ; 35 at $f_0 - 200$
DF2403S20A	2403	$f_0 \pm 10$	3.0	0.5	1.5	35 at $f_0 + 75$
DF2475S20A	2475	$f_0 \pm 10$	3.0	0.5	1.5	35 at $f_0 - 75$



## ► DF Filter Typical Characteristic

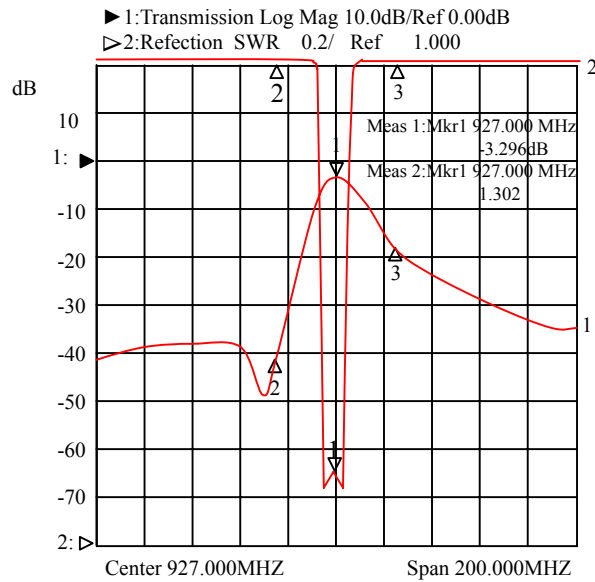
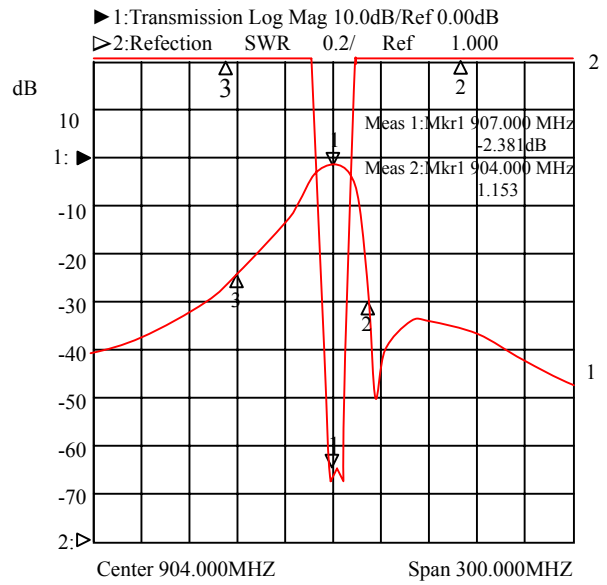
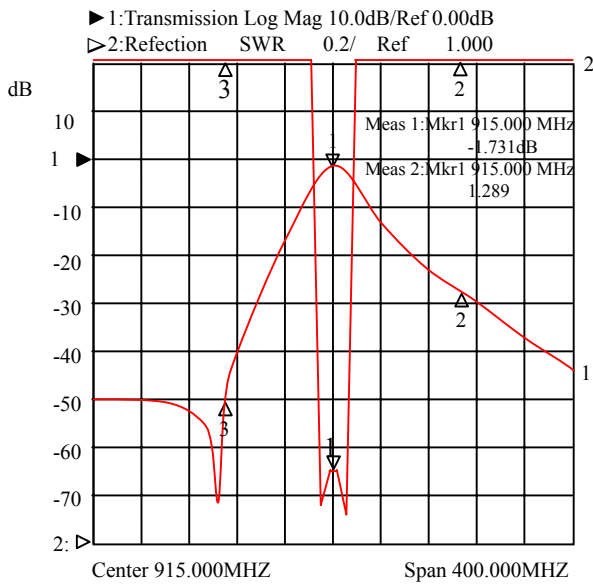



# Dielectric

## DF Band Pass Series Dielectric Filter

DF Series (SMD type) with high permittivity, high dielectric constants, extremely temperature stability and high Q that enables the design of stable microwave oscillators and filters. High dielectric materials and associated products are also available for custom application requirements. Applications for CT1, CT2, 900MHz, 1.8GHz, 2.4GHz, 5.8GHz Cordless Phone, wireless earphone, wireless microphone.

### ► Band Pass Filters DF - B Type Configuration



### DF - B Type Dimensions (Unit: mm)

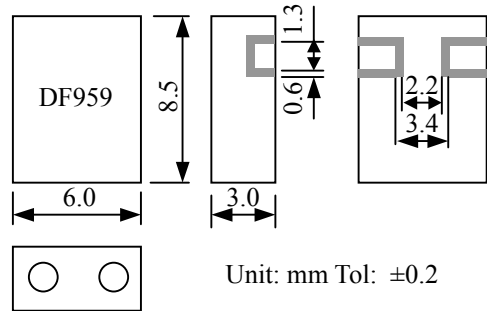

### ► Dielectric DF Filter Typical Specifications

Part No.	Center Frequency (MHz)	Band Width (MHz)	Insertion Loss (dB)max.	Ripple in Band Width (dB)max.	V.S.W.R max.	Attenuation (dB)min.(MHz)
DF650S30B	650	fo±15	2.5	0.5	1.5	19 at fo±64
DF700S20B	700	fo±10	2.5	0.5	1.5	19 at fo±64
DF710S08B	710	fo±4	5.0	0.5	1.5	35 at fo+100; 28 at fo+50
DF746S20B	746	fo±10	2.5	0.5	1.5	12 at fo-20
DF758S16B	758	fo±8	2.5	0.5	1.5	19 at fo±64
DF794S20B	794	fo±10	2.5	0.5	1.5	19 at fo±64
DF800S08B	800	fo±4	5.0	0.5	1.5	35 at fo+100; 28 at fo+50
DF836S20B	836	fo±10	2.5	0.5	1.5	19 at fo+52
DF850S08B	850	fo±4	5.0	0.5	1.5	30 at fo+100; 40 at fo-200
DF863S22B	863	fo±11	2.0	0.5	1.5	50 at fo-90; 20 at fo+90
DF875S24B	875	fo±12	2.3	0.5	1.5	30 at fo-70
DF903S09B	903	fo±4.5	3.5	0.5	1.5	34 at fo-64; 41 at fo+64
DF906S20B	906	fo±10	2.5	0.5	1.5	19 at fo±64
DF916S30B	916	fo±15	2.7	0.5	1.5	20.5 at fo±70



# Dielectric

## ► Filters Typical Characteristic

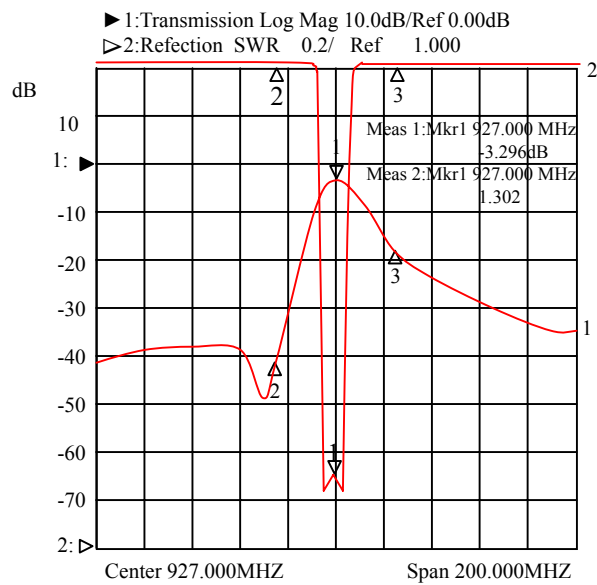
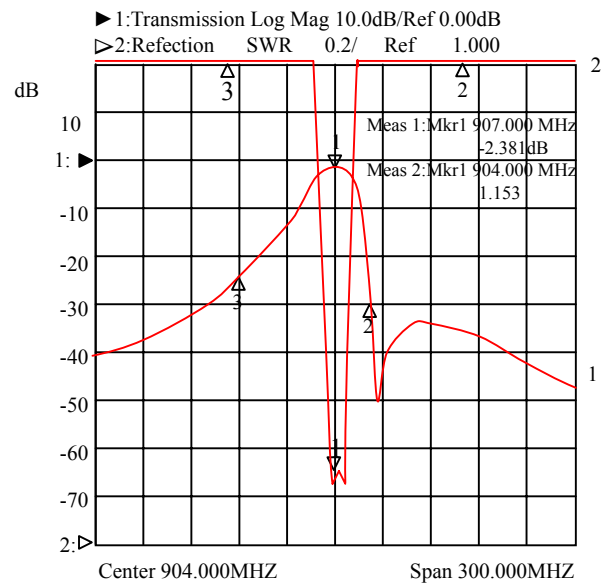
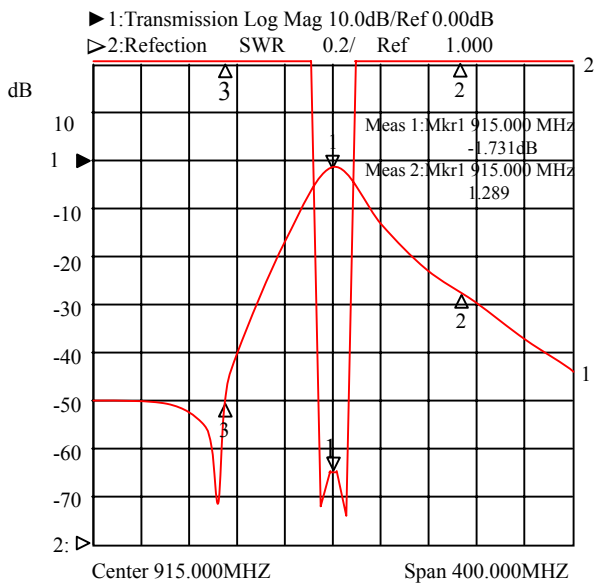



# Dielectric

## DF Band Pass Series Dielectric Filters / 帶通濾波器

DF Series (SMD type) Filter with high permittivity, high dielectric constants, extremely temperature stability and high Q that enables the design of stable microwave oscillators and filters. High dielectric materials and associated products are also available for custom application requirements. For CT1, CT2, 900MHz, 1.8GHz, 2.4GHz, 5.8GHz Cordless Phone.

### DF - C & D Type Filter Configuration



### DF - C & D Type Dimensions

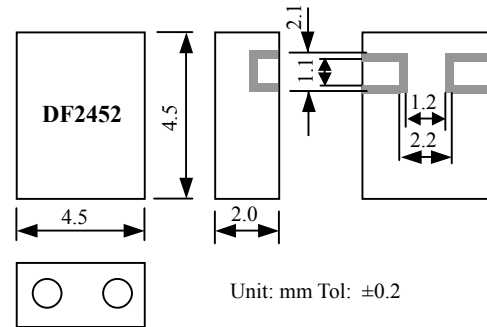

### Band Pass Filter DF Typical Specifications

Part No.	Center Frequency (MHz)	Band Width (MHz)	Insertion Loss (dB)max.	Ripple in Band Width (dB)max.	V.S.W.R max.	Attenuation (dB)min.(MHz)
DF1575S40C	1575	fo±20	2.0	0.7	2.0	20 at fo-100; 18 at fo+100
DF1855S70C	1855	fo±35	2.0	0.7	2.0	20 at fo+300; 20 at fo-300
DF1890S80C	1890	fo±40	2.0	0.7	2.0	15 at fo+250; 35 at fo-250
DF1950S90C	1950	fo±45	3.0	0.7	2.0	45 at fo+975; 45 at fo-975
DF2332S100C	2332	fo±50	2.5	0.7	2.0	25 at fo+500; 40 at fo-500
DF2450S100C	2450	fo±50	2.0	0.7	2.0	12 at fo+250; 15 at fo-250
DF3066S170D	3066	fo±85	2.0	1.0	2.0	10 at fo+300; 15 at fo-300
DF3480S120D	3480	fo±60	2.0	1.0	2.0	10 at fo+500; 20 at fo-500
DF3650S150D	3650	fo±75	2.0	1.0	2.0	15 at fo+750; 25 at fo-750
DF4880S160D	4880	fo±80	2.0	1.0	2.0	5 at fo+350; 15 at fo-350
DF5800S200D	5800	fo±100	2.0	1.0	2.0	5 at fo+400; 15 at fo-400

### Filter Typical Characteristic

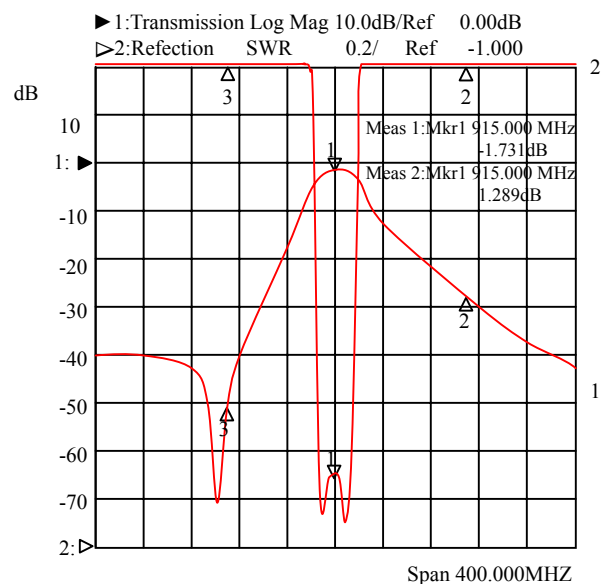
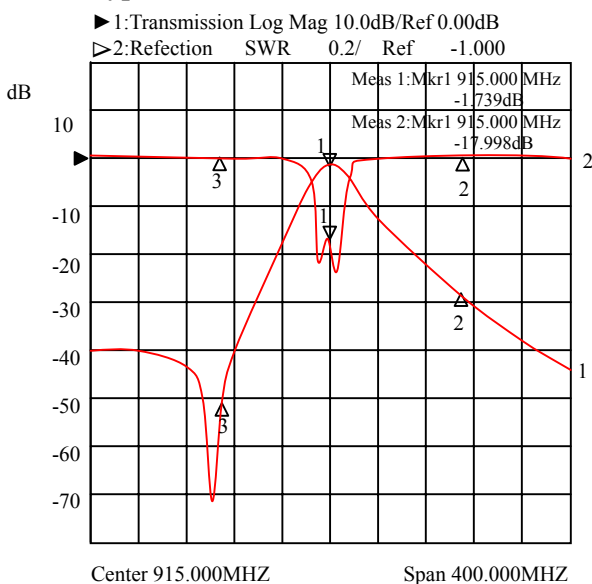



# Dielectric

## ► How to Order (For 2 Pole)

DF	864	S	10	A
❶	❷	❸	❹	❺

❶ Dielectric Filter

❷ Center Frequency

❸ Connect Type S: SMD type

❹ Bandwidth

❺ Size

Code	Size
A	7.3*3.6
B	6.0*3.0
C	4.5*2.0
D	3.6*1.8





# Dielectric

## DF Band Pass Series

### Dielectric Filters Features ( Murata DFC Series Compatible )

- 1.MBP 42R Series.
- 2.For CT1, CT2, 900MH, 1.8GHz, 2.4G WLL Cordless phone.

### Dielectric DF Filter Configuration



### DF Dimensions (DF33R815S20B)

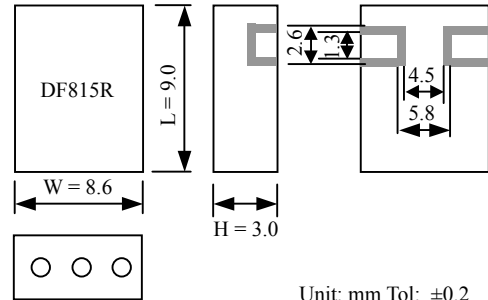

### Dielectric DF Filters Typical Specifications

Part No.	Center Frequency fo(MHz)	Band Width (MHz)	Insertion Loss (dB) max.	Ripple in Band Width (dB)max.	V.S.W.R max.	Attenuation (dB) min.(MHz)
DF43R860S20A	860	fo±10	3.0	0.8	2.0	-25 at fo+30 -22 at fo-30
DF43R1855S10A	1855	fo±5	3.5	1.0	2.0	-30 at fo+100 -28 at fo-100
DF43R950S20A	950	fo±10	3.5	0.8	2.0	-40 at fo+30 -35 at fo-30
DF44R3120S60A	3120	fo±30	3.0	1.0	1.5	-58 at fo+355 -55 at fo-375
DF45R1120S40A	1120	fo±20	2.5	1.0	2.0	-50 at fo+50 -50 at fo-50
DF33R815S20B	815	fo±10	2.5	0.8	2.0	-18 at fo+40 -25 at fo-40
DF33R1880S50B	1880	fo±25	3.5	1.0	2.0	-40 at fo+150 -40 at fo-150
DF23R1480S40C	1480	fo±20	2.5	1.0	2.0	-20 at fo+150 -20 at fo-150
DF23R1960S60C	1960	fo±30	2.0	1.0	2.0	-20 at fo+200 -20 at fo-200
DF23R2480S30C	2480	fo±15	2.5	1.0	2.0	-20 at fo+250 -20 at fo-250
DF23R5800S200D	5800	fo±100	2.0	1.0	2.0	-5 at fo+400 -15 at fo-400





# Dielectric

## ► Filter Typical Characteristic

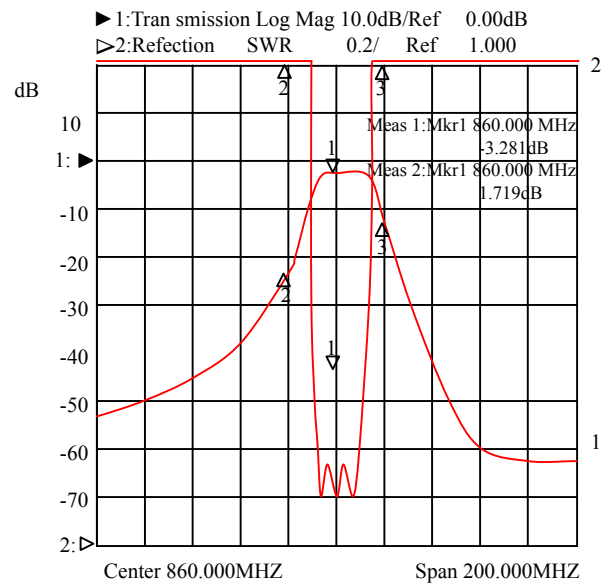
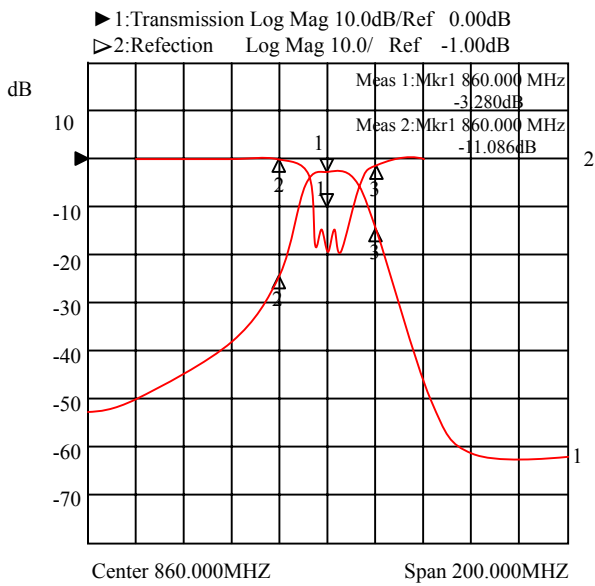

## ► How to Order (For More Pole)

- |    |   |    |     |   |    |   |
|----|---|----|-----|---|----|---|
| DF | 3 | 3R | 815 | S | 20 | B |
| ①  | ② | ③  | ④   | ⑤ | ⑥  | ⑦ |

① Dielectric Filter

② Thickness

Code	Thickness
4	3.8mm
3	3.0mm
2	2.0mm

③ Number of Resonator

④ Center Frequency (MHz)

⑤ Connect type

Code	Connect type
S	SMD type

⑥ Band width (MHz)

⑦ Size(W×H)(mm)

Code	Size(W×H)(mm)
A	11.8×3.8
B	8.6×3.0
C	5.8×2.0



# Dielectric

## Band Pass Dielectric Series / 帶通滤波器

### Band Pass Filter Features

- SMD Type
- Small and light
- Temperature compensated
- Low insertion loss
- High frequency selectivity

### Band Pass Filter Applications

- Cellular phone
- Cordless phone
- Trunked radio system
- Military affairs
- Base station

### DF Filters Configuration



### DF Dimensions

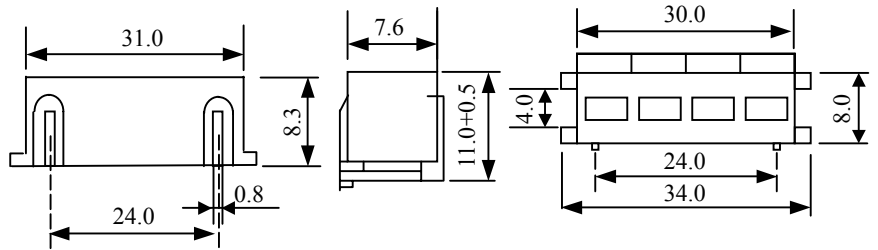

### Dielectric DF Typical Specifications

Part Number	Center Frequency fo(MHz)	Band Width (MHz)	Insertion Loss (dB)max.	Ripple in Band Width(dB)max.	V.S.W.R max.	Attenuation (dB)min.(MHz)
BP63R915-01	915	fo±5	2.5	0.5	1.5	45 at fo±100
BP64R881-02	881	fo±10	2.0	0.5	2.0	60 at fo±100
BP84R650-01	650	fo±5	2.5	0.5	1.5	70 at fo ±55
BP84R1200-03	1200	fo±15	2.0	0.5	2.0	70 at fo ±60
BP74R959-02	959	fo±10	2.0	0.5	2.0	70 at fo ±80
BP75R836-01	836	fo±5	3.5	0.5	1.5	80 at fo ±50
BP76R1220-02	1220	fo±10	2.5	0.5	2.0	80 at fo ±50

### How to Order

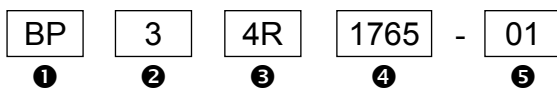

- ① Band Pass Filter
- ② Thickness
- ③ Number of Resonator
- ④ Center Frequency (MHz)
- ⑤ BandWidth

Code	BandWidth
01	10MHz
02	20MHz
03	30MHz



# Dielectric

## DF Band Pass Series Dielectric Filters

### Band Pass Filter Features

- SMD Type
- Small and light
- Temperature compensated
- Low insertion loss
- High frequency selectivity

### Band Pass Filter Applications

- Cellular phone
- Cordless phone
- Trunked radio system
- Military affairs
- Base station

### Dielectric DF Filters Configuration



### DF Dimensions

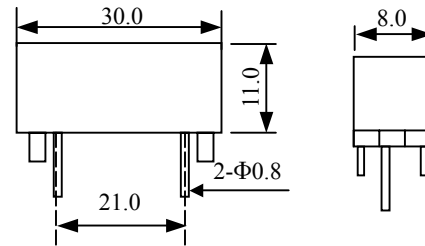

### DF Filters Typical Specifications

Part No.	Center Frequency fo(MHz)	Band Width (MHz)	Insertion Loss (dB) max.	Ripple in Band Width(dB)max.	V.S.W.R max.	Attenuation (dB) min.(MHz)
LJ900-C-A	900	fo±10	2.5	0.5	1.5	50 at fo±100
LJ1200-C-B	1200	fo±15	2.0	0.8	2.0	50 at fo±110
LJ950-D-B	950	fo±10	2.5	0.5	1.5	60 at fo ±100
LJ1250-D-B	1250	fo±15	2.0	0.8	2.0	60 at fo ±110

### Band Pass Filters Typical Characteristic

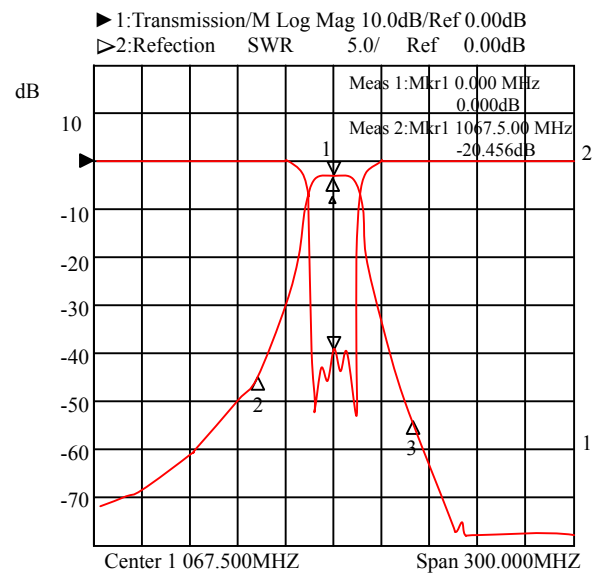
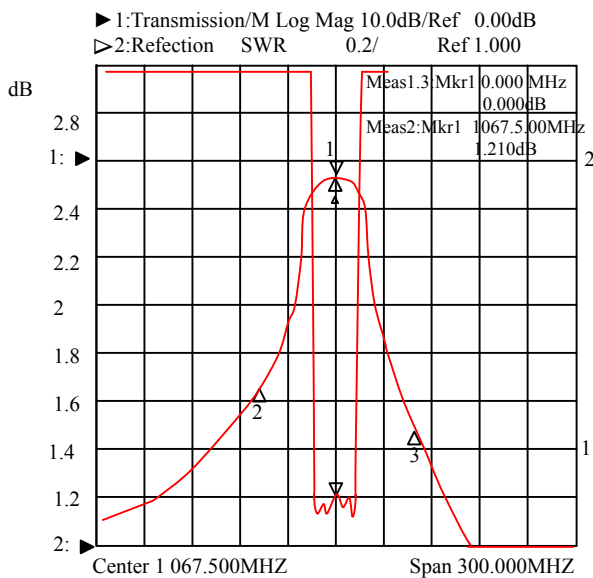

### How to Order



① Dielectric Filter

③ Number of Resonator

Code	Number of Resonator
C	3
D	4

② Center Frequency (MHz)

④ Band Width

Code	Band Width
A	10 MHz
B	20 MHz





# Dielectric

## Band Pass Series Dielectric Filters

### ► Features

- SMD Type
- Small and light
- Temperature compensated
- Low insertion loss
- High frequency selectivity

### ► Applications

- Cellular phone
- Cordless phone
- Trunked radio system
- Military affairs
- Base station

### ► DF Band Pass Filter Configuration



### ► DF Dimensions

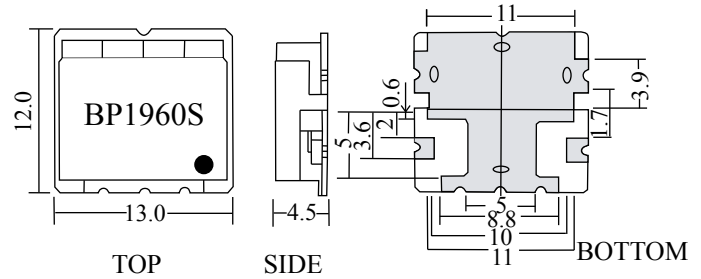

Unit:mm Tol:±0.2

### ► DF Band Pass Filters Typical Specifications

Part No.	Center Frequency fo(MHz)	Band Width (MHz)	Insertion Loss (dB)max.	Ripple in Band Width(dB)max.	V.S.W.R max.	Attenuation (dB)min.(MHz)
BP33R881S30A	881.5	fo±12.5	2.5	1.0	1.8	53 at fo±779
BP64R836S30A	836.5	fo±15	3.0	1.2	1.7	18 at fo±32.5
BP64R881S30A	881.5	fo±15	3.0	1.2	1.7	18 at fo±32.5
BP34R1765S30A	1765	fo±15	3.5	1.0	1.8	30 at fo±90
BP34R1855S30A	1855	fo±15	3.5	1.0	1.8	30 at fo±90
BP55R1750S60A	1750	fo±30	3.0	1.5	1.7	30 at fo±1810
BP55R1765S10A	1765	fo±5	5.0	1.0	1.8	20 at fo±20
BP55R1765S30A	1765	fo±15	3.0	1.3	1.6	40 at fo±80
BP55R1855S10A	1855	fo±5	5.0	1.0	1.8	20 at fo±20
BP55R1855S30A	1855	fo±15	3.8	1.3	1.6	40 at fo±80
BP66R1755S10A	1755	fo±5	10.0	1.0	2.0	22at fo±1765
BP66R1845S10A	1845	fo±4.5	13.0	3.0	2.0	28 at fo±1855
BP34R2315S30A	2315	fo±15	2.7	1.0	1.7	40 at fo±160
BP34R2385S30A	2385	fo±15	2.7	1.0	1.7	40 at fo±160
BP34R2442S80A	2442	fo±42	2.5	1.0	1.7	40 at fo±160
BP64R409S10A	409.5	fo±3.5	3.0	0.8	1.7	30 at fo±423
BP64R426S10A	426.5	fo±3.5	3.0	0.8	1.7	30 at fo±413
BP66R1410S30A	1410	fo±14.5	3.0	1.0	1.5	18 at fo±34.5
BP86R1474S10A	1474	fo±2.5	12.0	2.8	2.0	15 at fo±10
BP34R1880S60A	1880	fo±32.5	2.5	1.0	1.5	18 at fo±100
BP34R1960S60A	1960	fo±32.5	3.0	1.0	1.4	45 at fo±130
BP34R1950S60A	1950	fo±30	3.0	1.0	1.8	38 at fo±60
BP34R2140S60A	2140	fo±30	3.0	1.0	1.8	38 at fo±60



# Dielectric

## ► How to Order

- BP
- 3
- 4R
- 1765
- S
- 30
- A

- ❶
- ❷
- ❸
- ❹
- ❺
- ❻
- ❼

- ❶ Band Pass Filter
- ❷ Thickness
- ❸ Number of Resonator
- ❹ Center Frequency (MHz)
- ❺ Connect type s: SMD type
- ❻ BandWidth

Code	BandWidth
10	10MHz
30	30MHz
60	60MHz

- ❼ Version





# Dielectric

## TE<sub>018</sub> Mode Dielectric Resonators / 介质谐振器

### ► Features

- High Q Value
- Easy to control  $\tau f$
- Many kinds of material with various dielectric constants

### ► Applications

- Cellular Base Station Filter, Duplexer & Combiners
- PCS/PCN Filters, Duplexer & Combiners
- Police Radar Detectors
- LMDS/MMDS Wireless Cable TV
- Automobile Collision Avoidance Sensors
- Dielectric Resonator Antennas
- LNB



### ► TE Resonator Available Range by Every Material

Material Series	Dielectric Constant	Fo Q(1/tanδ)	Temperature Coefficient (PPM/°C)	Insulation Resistance (Ω-cm)	Application Frequency Range	Application Range
TE21	19~22	6,000@10GHz	0 ± 3	>10 <sup>14</sup>	Refer Frequency Chat	Refer Frequency Chat
TE30	29~30	15,000@10GHz	0 ± 6	>10 <sup>14</sup>		
TE36	35~37	10,000@4GHz	0 ± 3	>10 <sup>14</sup>		
TE45	44~46	10,000@4GHz	0 ± 6	>10 <sup>14</sup>		
TE80	79~81	7,000@1GHz	0 ± 6	>10 <sup>14</sup>		
TE90	89~91	7,000@1GHz	0 ± 6	>10 <sup>14</sup>		

### ► Dielectric TE<sub>018</sub> Mode Frequency Chart

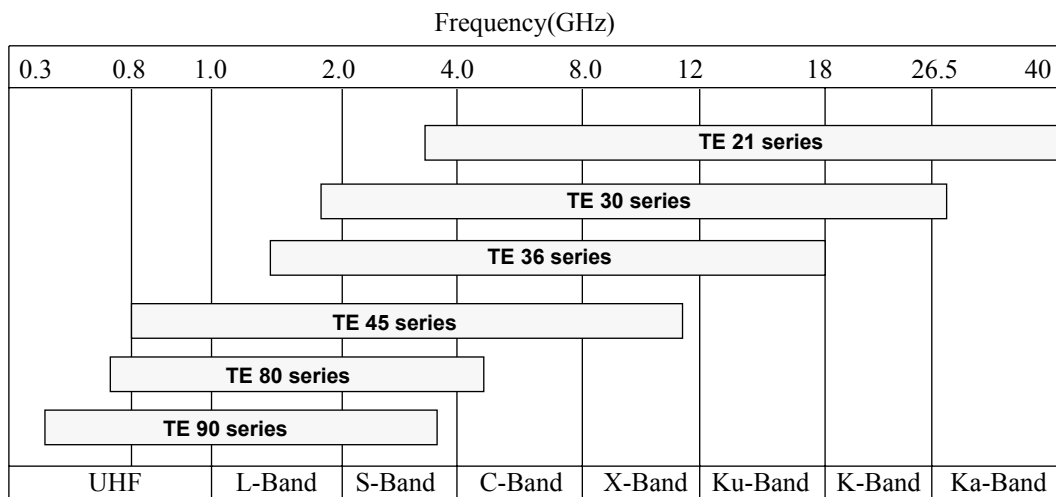



# Dielectric

## ► How to Order

TE	36	10	A	S
❶	❷	❸	❹	❺

❶ Product Type

❷ Dielectric Constant

❸ Center Frequency (GHz)

❹ Configuration

Code	Configuration
A	With hole
B	Without hole

❺ Construction

Code	Construction
S	Support
	Without support



# Dielectric

## Coaxial Resonators - TEM Mode Dielectric DR Series / 同轴谐振器

Dielectric DR Series are widely used in voltage controlled oscillators and filters for cellular phone, cordless phone and so on. Features with high dielectric constant and high Q, excellent Solderability. Token DR series designs are available from 800 MHz to 4800 MHz by 10 MHz standard and custom packages are available. Please consult our sales representatives or engineers as regards the products for other frequency

### ► Features

- High dielectric constant
- Low temperature coefficient
- High quality factor
- Wide range of resonant frequency

### ► Applications

- Oscillators (DRO/VCO)
- 900MHz, 1.8GHz, 2.4GHz, 5.8GHz wireless phone
- Wireless headphone, wireless security system
- Filter and duplexer
- CDMA/PCS/WLL/IMT2000



### ► Coaxial DR Resonators Dimensions (Unit: mm)

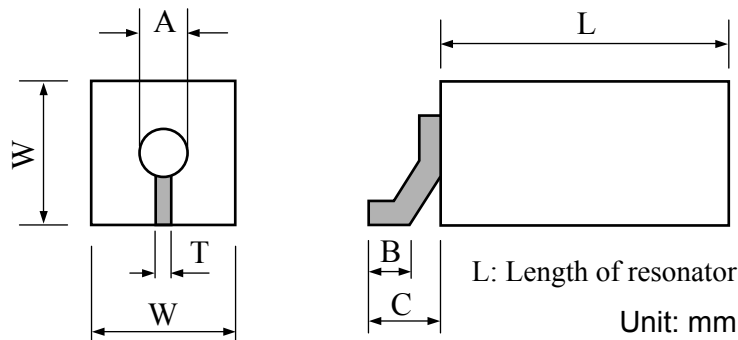

### ► Coaxial DR Resonators Specifications

Part Number	W(O/D)	A(I/D)	B	C	T
D120	12.0±0.2	① Φ4.0±0.2	without tab	3.2	1.0
		② Φ3.55±0.2	1.5		
D100	10.0±0.2	① Φ3.3±0.2	1.3	3.0	1.0
D080	8.0±0.2	① Φ2.7±0.2	1.3	2.6	0.7
D060	6.0±0.2	① Φ2.5±0.2	without tab	2.4	0.7
		② Φ2.2±0.2	without tab		
		③ Φ2.0±0.2	1.2		
D050	5.0±0.2	① Φ1.8±0.2	1.0	2.2	0.6
		② Φ1.5±0.2	1.0		
D040	4.0±0.1	① Φ1.8±0.1	0.8	1.8	0.6
		② Φ1.5±0.1	without tab		
		③ Φ1.2±0.1	without tab		
D030	3.0±0.1	① Φ1.0±0.1	0.7	1.5	0.5
D020	2.1±0.1	① Φ0.6±0.1	0.5	1.2	0.5





# Dielectric

## ► Available Range of TEM Mode DR Series Resonators

Material	Dielectric Constant	Tf <sup>[1]</sup>	Type	Characteristic Impedance (Ω)	Wave Length	Frequency Range (MHz)	Q <sup>[2]</sup> (min)
A Series	21±1	0±10	D120	⓪15 ㉔17	λ/4	800~1300	800
					λ/2	1600~2700	1000
			D100	16	λ/4	800~1300	700
					λ/2	1600~3200	800
			D080	15	λ/4	1000~3200	650
					λ/2	2000~3000	700
			D060	⓪12 ㉔14 ㉔15	λ/4	1000~2700	550
					λ/2	2000~3000	600
			D050	⓪14 ㉔17	λ/4	1300~3000	450
					λ/2	2500~4000	500
			D040	⓪11 ㉔14 ㉔17	λ/4	1300~4000	380
					λ/2	2500~4000	400
			D030 D020	15	λ/4	1900~4000	320
				17	λ/4	2800~5000	250
B Series	36±1	0±10	D120	⓪12 ㉔13	λ/4	600~1000	700
					λ/2	1200~2400	900
			D100	12	λ/4	600~1200	600
					λ/2	1200~2400	800
			D080	12	λ/4	800~1500	500
					λ/2	1600~3000	700
			D060	⓪10 ㉔11 ㉔12	λ/4	800~1800	450
					λ/2	1600~3500	550
			D050	⓪11 ㉔13	λ/4	800~1800	380
					λ/2	1600~3500	450
			D040	⓪9 ㉔11 ㉔13	λ/4	1000~2700	320
					λ/2	2000~4800	400
			D030 D020	12	λ/4	1300~3000	220
				13	λ/4	1300~3000	220
C Series	90±2	0±10	D120	⓪7 ㉔8	λ/4	400~800	650
					λ/2	800~1500	700
			D100	7	λ/4	600~800	550
					λ/2	1200~2400	650
			D080	7	λ/4	440~1000	450
					λ/2	1000~1500	550
			D060	⓪6 ㉔7 ㉔7	λ/4	440~1300	400
					λ/2	1000~2200	470
			D050	⓪7 ㉔8	λ/4	500~1800	380
					λ/2	1000~3000	450
			D040	⓪6 ㉔7 ㉔8	λ/4	900~1600	200
					λ/2	2000~4800	300
			D030 D020	7	λ/4	900~1600	250
				8	λ/4	900~1600	150

[1]Frequency stability of temperature

[2]Q value depends on lower limit of frequency range





# Dielectric

## ► How to Order

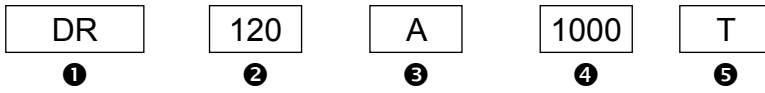

① Product Type :Dielectric Resonators

② Dimension

③ Material

④ Center Frequency (MHz)

⑤ Configuration

Code	Configuration
T	tab
N	without tab



# Dielectric

## Dielectric Antenna / 介质天线

### ► Features

- Small patch dimensions
- Provide highly stabilized performance
- Using high quality factor
- Stabilized temperature coefficient

### ► Applications

- GPS
- W-LAN



### ► Dielectric Antenna Typical Specification

Part Number	Size (mm)	Center Frequency (MHz)	Band width (MHz)	Gain (dBi)	Ground Plane (mm)	Application	
DA1575S25T4A	25*25*4	1575	≥10	4.5	35*35	GPS	
DA1575S25T4B	25*25*4	1575	≥10	4.5	70*70		
DA1575S25T2B	25*25*2	1575	≥10	4.5	70*70		
DA1580S25T4A	25*25*4	1580	≥15	4.5	35*35		
DA1580S25T4B	25*25*4	1580	≥15	4.5	70*70		
DA1580S25T2B	25*25*2	1580	≥15	4.5	70*70		
DA1580S18T4	18*18*4	1580	≥10	3.0	50*50		
DA1580S18T2	18*18*2	1580	≥10	3.0	50*50		
DA1580S13T4	13*13*4	1580	≥5	0.0	50*50		
DA2450S13T4	13*13*4	2450	≥5	0.0	50*50		
DA2450S13T2	13*13*2	2450	≥5	0.0	50*50		
DA1575S36T4	36*36*4	1575	≥30	5.0	80*80		
DA2450D16	Φ16	2450	45	2.1	50*70		W-LAN
DA1616S25(Tx)	25*25*4	1616	≥10	4.0	70*70		Beidou Satellite Position System
DA2492S25(Rx)	25*25*4	2492	≥10	4.0	70*70		

Note: Fo available on request. Other parameters available on request.



# Dielectric

## ► Patch Antenna Dimensions (Unit: mm)

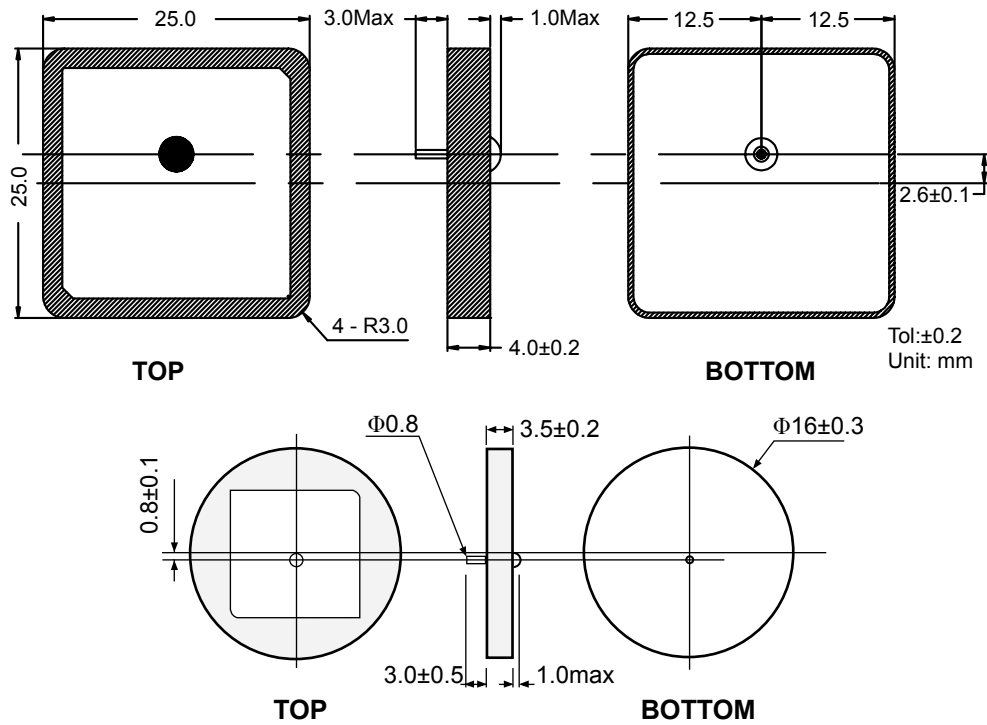

## ► Patch Antenna Typical Characteristic

CH1 MEN LOG 5dB/REF -15 dB 1:-32.692 dB 1 587.000 000 MHz  
 CH2 S11 1.005 U FS 1:50.766 Ω -2.3340 Ω 42.968 pF

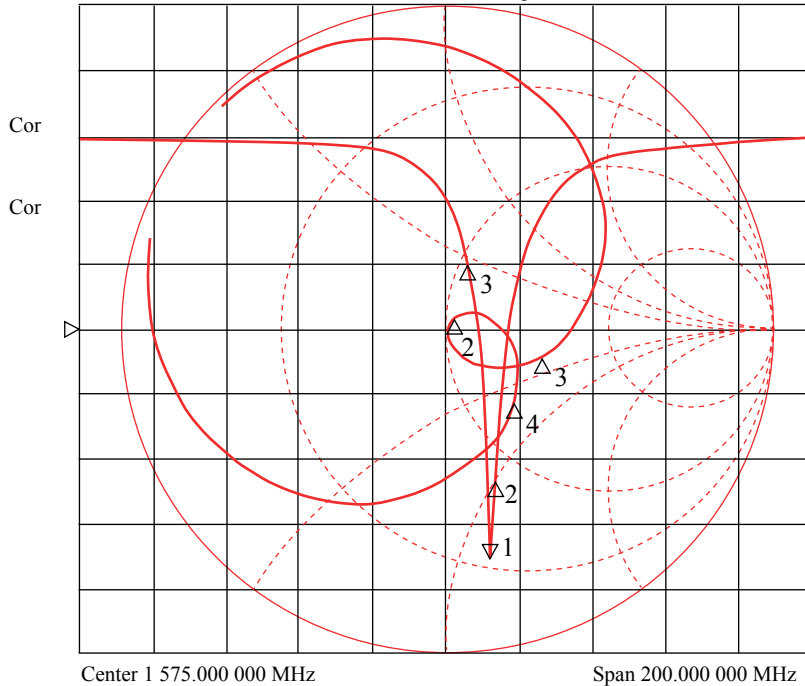

CH1 Markers  
 Min  
 BW: 14.104714 MHz  
 cent: 1588.480998 MHz  
 Q: 112.62  
 1 loss: -32.692 dB

CH3 Markers  
 2:52.898 Ω  
 3:6621 Ω  
 1.58848 GHz  
 3:92.797 Ω  
 -16.094 Ω  
 1.58142 GHz  
 4:66.164 Ω  
 -34.492 Ω  
 1.59553 GHz

## ► How to Order

DA 1580 S 18 T2  
 ① ② ③ ④ ⑤

- ① Dielectric Patch Antenna
- ② Center Frequency
- ③ Structure
- ④ Dimensions
- ⑤ Thickness